

CV5417/3.3

THE NEW UNDERGROUND BOOK-STORE  
OF THE BODLEIAN LIBRARY, OXFORD.

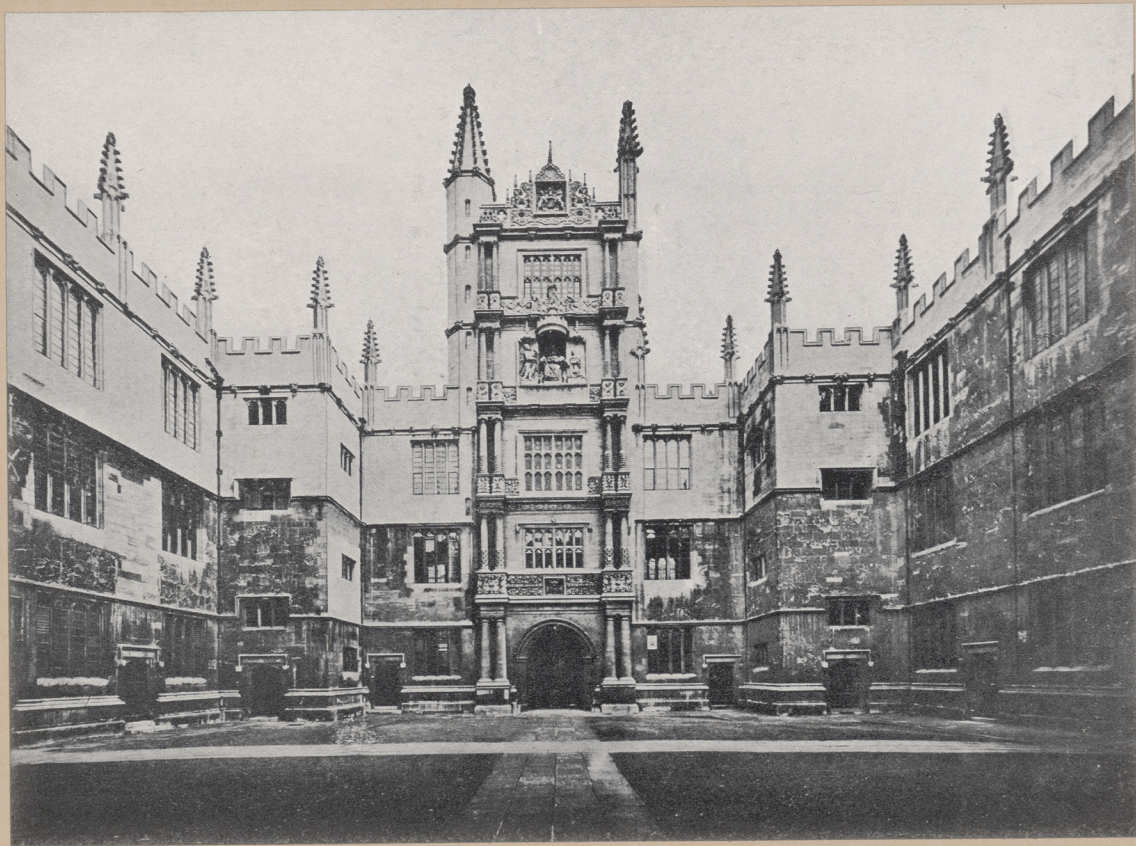

BODLEIAN QUADRANGLE, WITH "TOWER OF FIVE ORDERS."

W. LUCY & CO. LTD., ENGINEERS, FOUNDERS AND  
LIBRARY SPECIALISTS, ::  
EAGLE IRON WORKS, OXFORD.

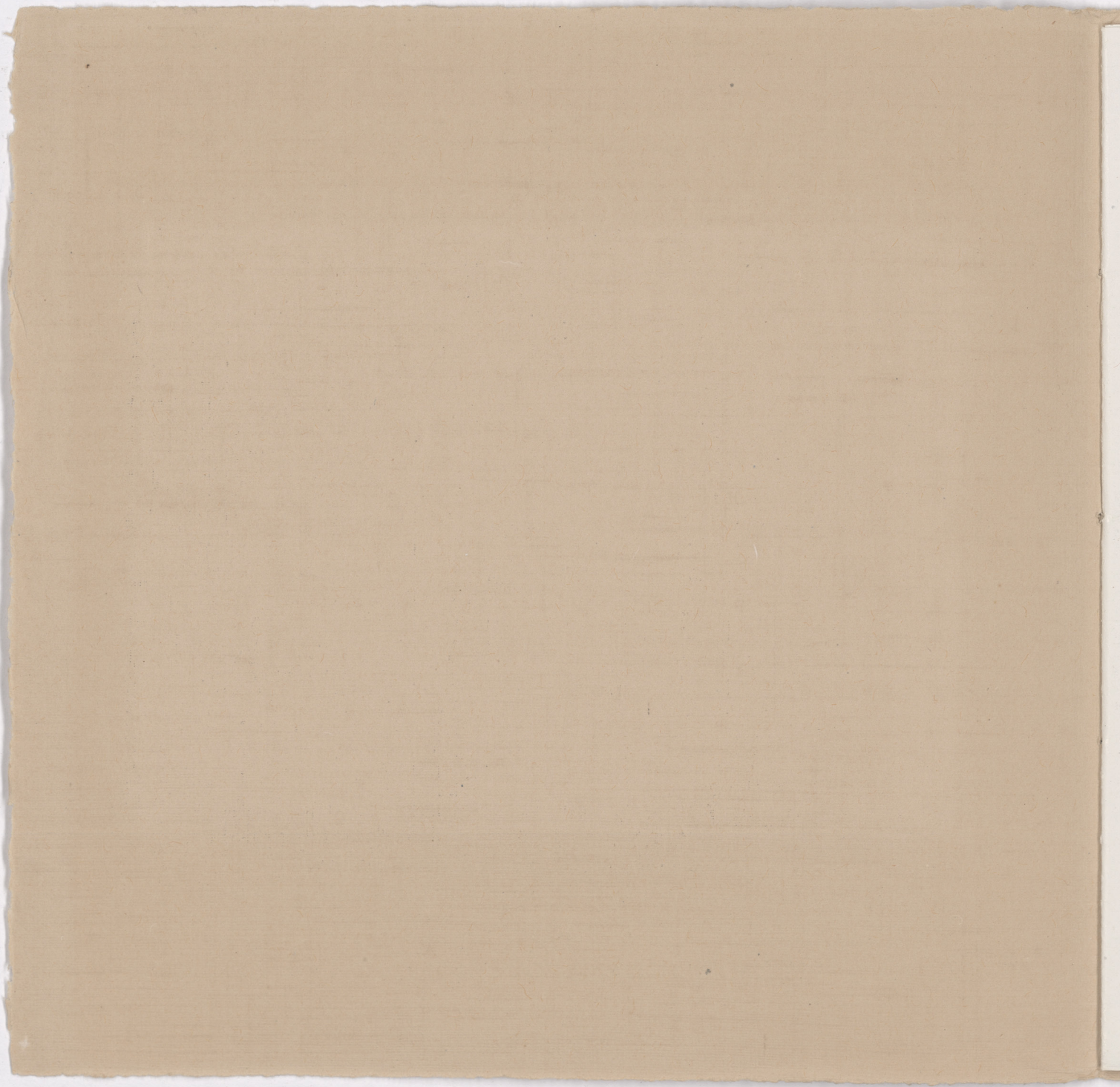

# THE NEW BOOK-STORE OF THE BODLEIAN LIBRARY.

---

---



THE Bodleian Library is familiar to all book lovers as the home of many literary treasures, which are stored with almost religious care. If the number of books were fixed, or increased very slowly, there would be no weighty architectural or engineering problems to be solved by the Librarian. But rapid growth is one of the features of the Bodleian, as indeed of all the leading Libraries, and provision for additional storage of books is an ever-present necessity. One of the chief reasons of the Bodleian's expansion is the privilege it has, under the Copyright Act, of receiving a copy of every book published in Great Britain. This privilege entails the corresponding obligation of preserving all copies without discrimination. Owing to this cause and to the ordinary purchases and exchanges, the annual increase may be as much as 50,000 volumes. There is no appearance of any diminished activity in the publishing world, and some such figure must therefore be contemplated as the normal number of books for which storage must be provided. This problem of storage is not easily solved. In a small city like Oxford, crowded with venerable

buildings, it is impossible to indulge in the methods of Haussmann. (In a modern city like Berlin, on the other hand, a site of over five acres adjoining the University was recently cleared for the New Royal Library.)

The only alternative left to the Bodleian, if the vistas and amenity of the historic buildings in its neighbourhood were to be kept unimpaired, was to find the necessary storage room underground. This proved, on investigation, to be a most practicable scheme, both for the extent of storage available and the easy access to other Library premises, without any noticeable alteration above-ground.

The usual modern construction for a book-store—a steel stack of numerous tiers with fireproof intermediate floors—was undesirable, on account of the level at which water would be found.

The underground chamber was, therefore, limited to a depth of 16 ft.—sufficient for two tiers of book-stacks.

The store occupies practically the whole of the space between the Bodleian building and the Radcliffe Camera, with both of which it communicates directly by staircases and tunnels. Its relative position and dimensions are seen in Figs. 1 and 2. The equipment consists of enamelled metal stacks of the rolling type, which give the most efficient use of the space. A full description of the various forms of rolling stack may be found in Messrs. Lucy and Company's Library Catalogue. It is only necessary here to refer to the principles of the system. A row of stacks is hung from joists on ball-bearing wheels in such a way that their ends are all next a gangway. A



RADCLIFFE CAMERA. READING ROOM OF BODLEIAN.

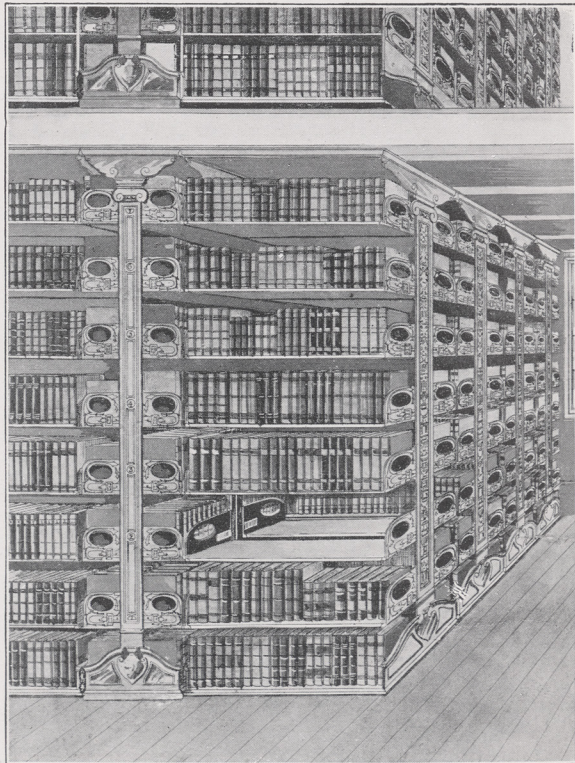
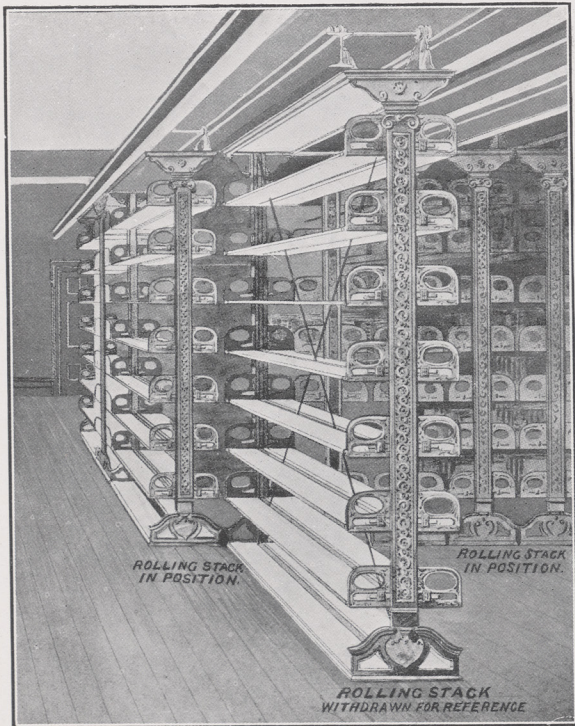

ROLLING STACK SYSTEM.

similar row is placed on the opposite side of the gangway. As seen in Fig. 2, any one stack can be independently drawn out into the gangway, permitting easy access to the shelves on either side of the stack, after which it is pushed back into its original position. The movement of the stack requires very little effort, as there is a minimum of friction in the ball-bearing wheels.

The steel work in the Bodleian book-store was specially designed for the rolling stack system on both floors. The height is convenient—about 7 ft. 6 in. each—and the joists, which form the run-ways for the wheels of the stacks, were all spaced correctly during construction. The stacks in the upper tier only are hung from joists, those below rolling directly on rails in the floor, thereby freeing the steel structure from unnecessary weight. A light iron grating serves as the intermediate floor, and it carries none of the weight of the stacks. If the geometrical idea of the rolling stack arrangement has been grasped, it will be clear that, when any portion of such a store is fully occupied, nearly two-thirds of its cubical contents will be taken up by the books themselves, and the remaining third by gangways or corridors. (With ordinary fixed book-stacks the figures are practically reversed.) It will, therefore, be hardly surprising to learn that the underground store, as designed, will accommodate more than 1,000,000 volumes. It may be noted here that a similar space exists on the other side of the Radcliffe Camera between it and St. Mary's Church, which it is hoped can be utilized also for the construction of another store at a later date, so that the Library has accommodation in view for two or three generations.

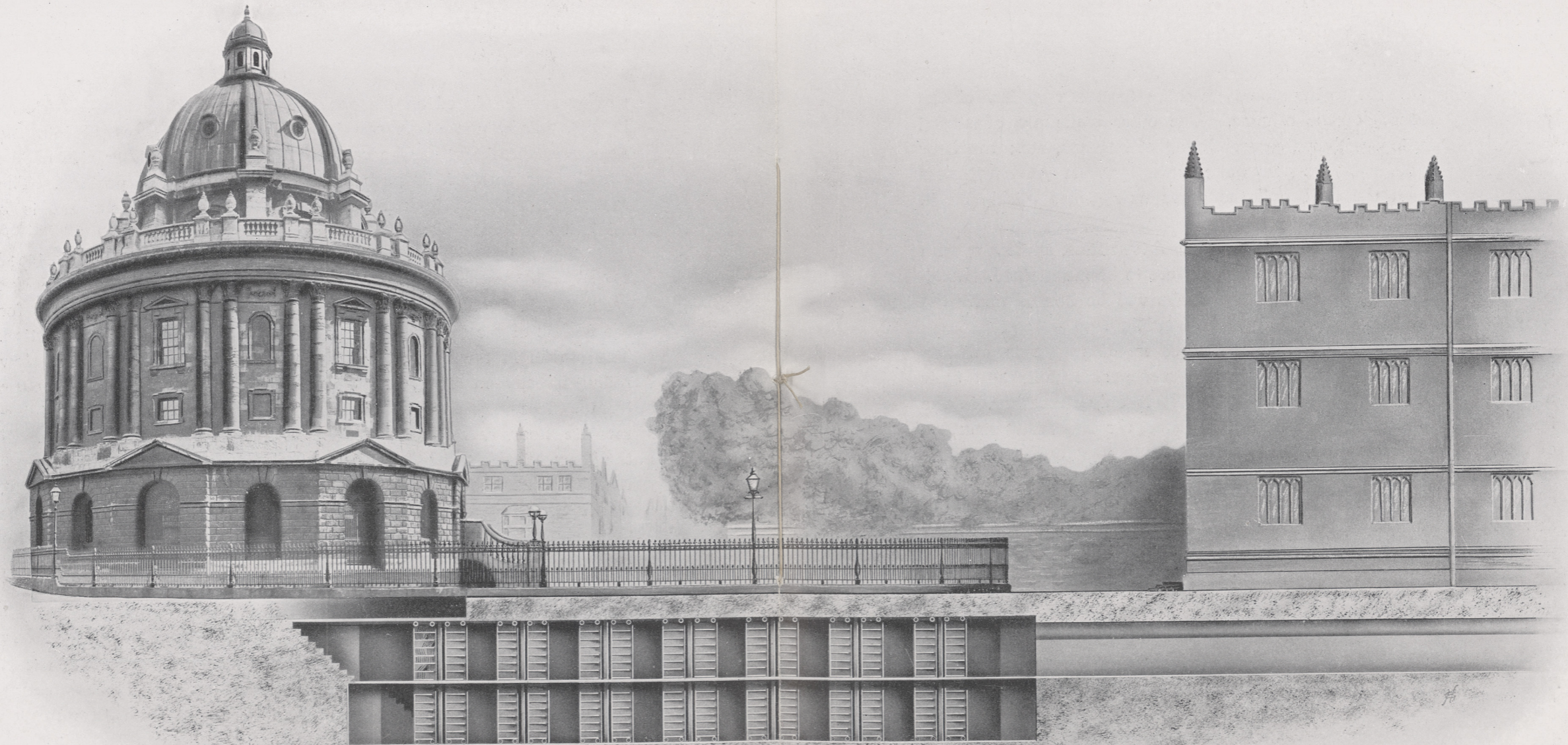

IDEAL SECTION OF THE NEW UNDERGROUND BOOK-STORE, SHEWING POSITION OF THE ADJACENT BUILDINGS.

(FIG. 1.)



It is impossible to mention here more than a very few of the engineering features of the scheme. The outer walls are of strong arched construction, with waterproof lining of bitumen, etc.; the floor and ferro-concrete roof are also quite watertight. A good thickness of soil is laid on the roof, and the grass now grows thickly on it, giving no hint of the treasures below.

Ventilation is provided by electrically driven fans, while a system of hot-air ducts enables a steady temperature to be maintained. Long-continued tests have shown that the books will be housed under the most favourable conditions as regards durability.

The rolling stack principle has another advantage in addition to its saving of space. Each stack is a separate unit, and their number can be added to at any time. It is only necessary, in the initial stages of a scheme of this kind, to erect the supporting structure of steel joists and stanchions, and from year to year sufficient rolling stacks can be installed as occasion requires. From the point of view of engineering design, it is preferable to sub-divide the weight into definite small units. The stack itself has been very carefully proportioned to withstand the maximum possible shock it may have to bear when fully loaded. (We give details of the construction in Fig. 3.) The uprights and brackets are made of ample strength to resist bending stresses. The wheels and ball-bearings have also been specially designed for the working conditions.

Permanent mechanical strength and safety are naturally very important features of a book-stack, which is expected to last as long

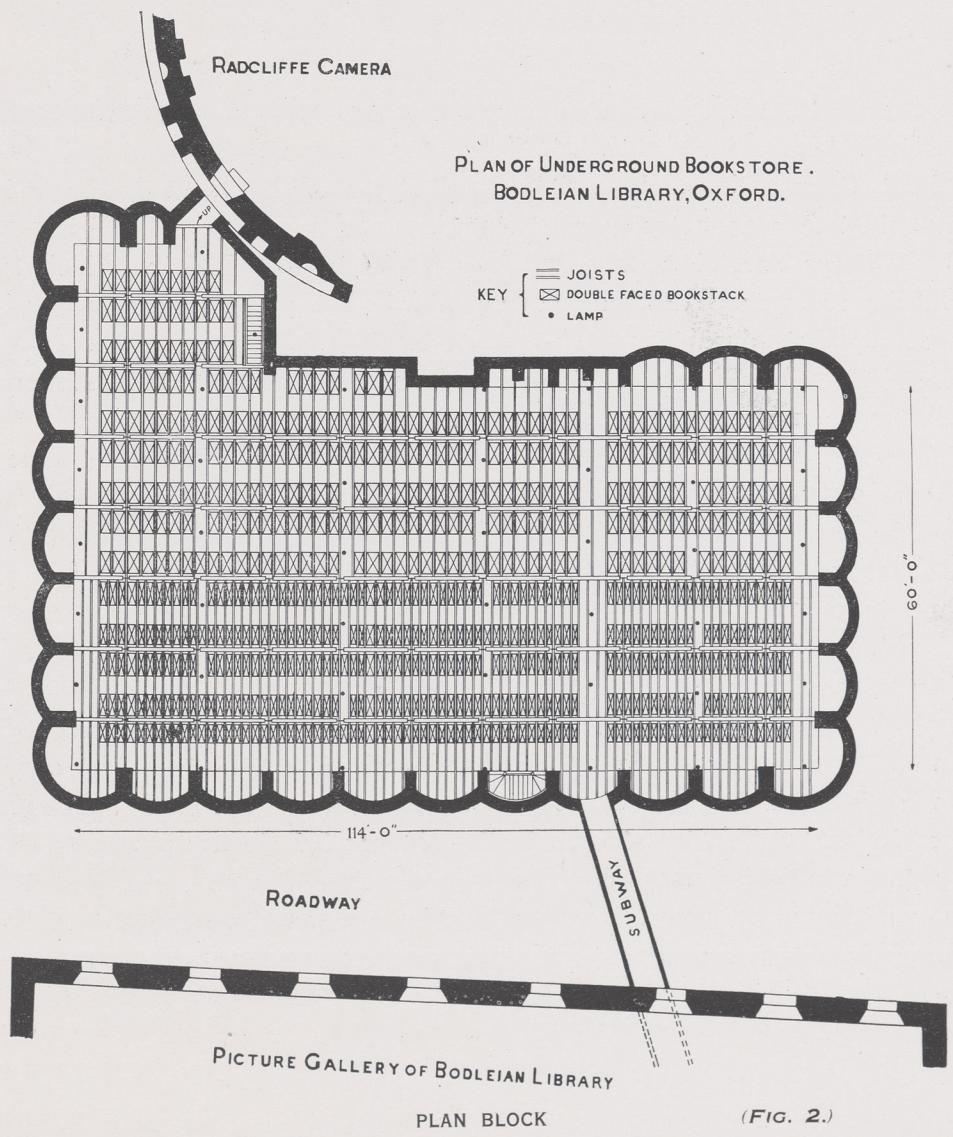

as the brickwork. The details of construction were therefore submitted to Prof. Jenkin, M.A., M.I.C.E., Prof. of Engineering Science, and Mr. Elliott-Cooper, Pres. Inst. C.E., and approved by them before the manufacture was actually commenced.

These special features are illustrated in Fig. 3, from which it will be recognized that the stacks will in all probability give good proof of their durability to future generations.

A final reference to the advantage of the rolling stack system of storage may not be out of place.

Although the underground storeroom, as described, was to some extent suggested by æsthetic considerations for existing buildings, it has led to the very satisfactory result that the books are stored in a concentrated form, and more convenient for access in many respects than in a stack involving hundreds of yards of corridors.

This will be appreciated on again examining the relative dimensions in the plan (Fig. 2).

With regard to cost, much has been saved by the absence of an ornamental frontage; all the brickwork—being buried—has only an engineering finish. There is, of course, a certain small charge for electric lighting, in addition to the amount for electric power taken by the ventilating motors. The use of electric wires, enclosed in heavy galvanized pipes, is perfectly safe, and as the current is only used when someone enters the store, the absence of natural daylight does not entail any serious expense, nor any appreciable danger from fire.

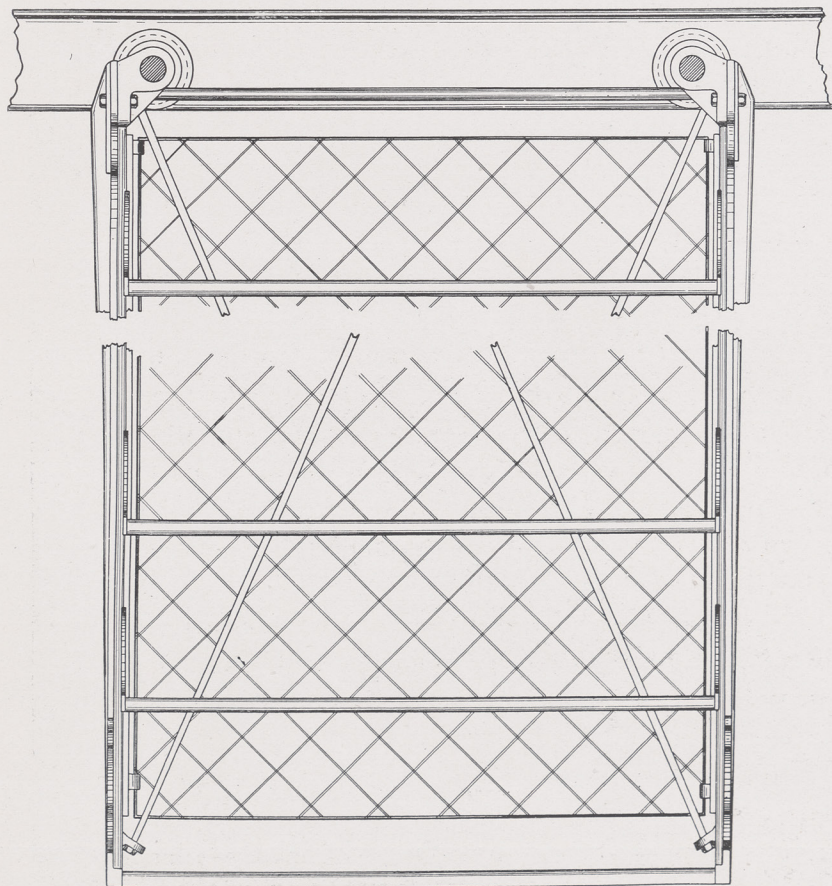

DETAILS OF ROLLING STACK.

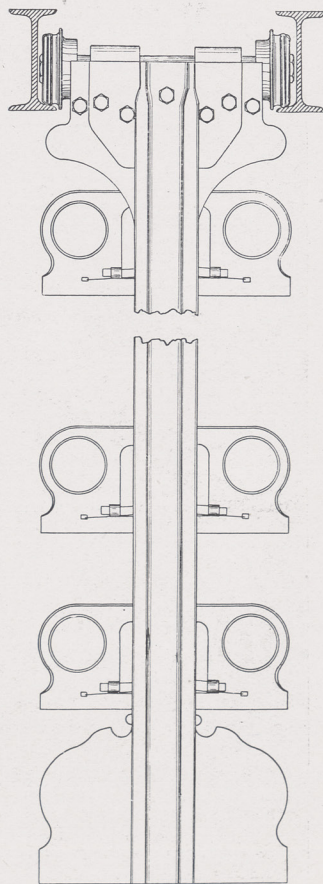

(FIG. 3.)



BODLEIAN QUADRANGLE (MAIN ENTRANCE TO LIBRARY ON LEFT).

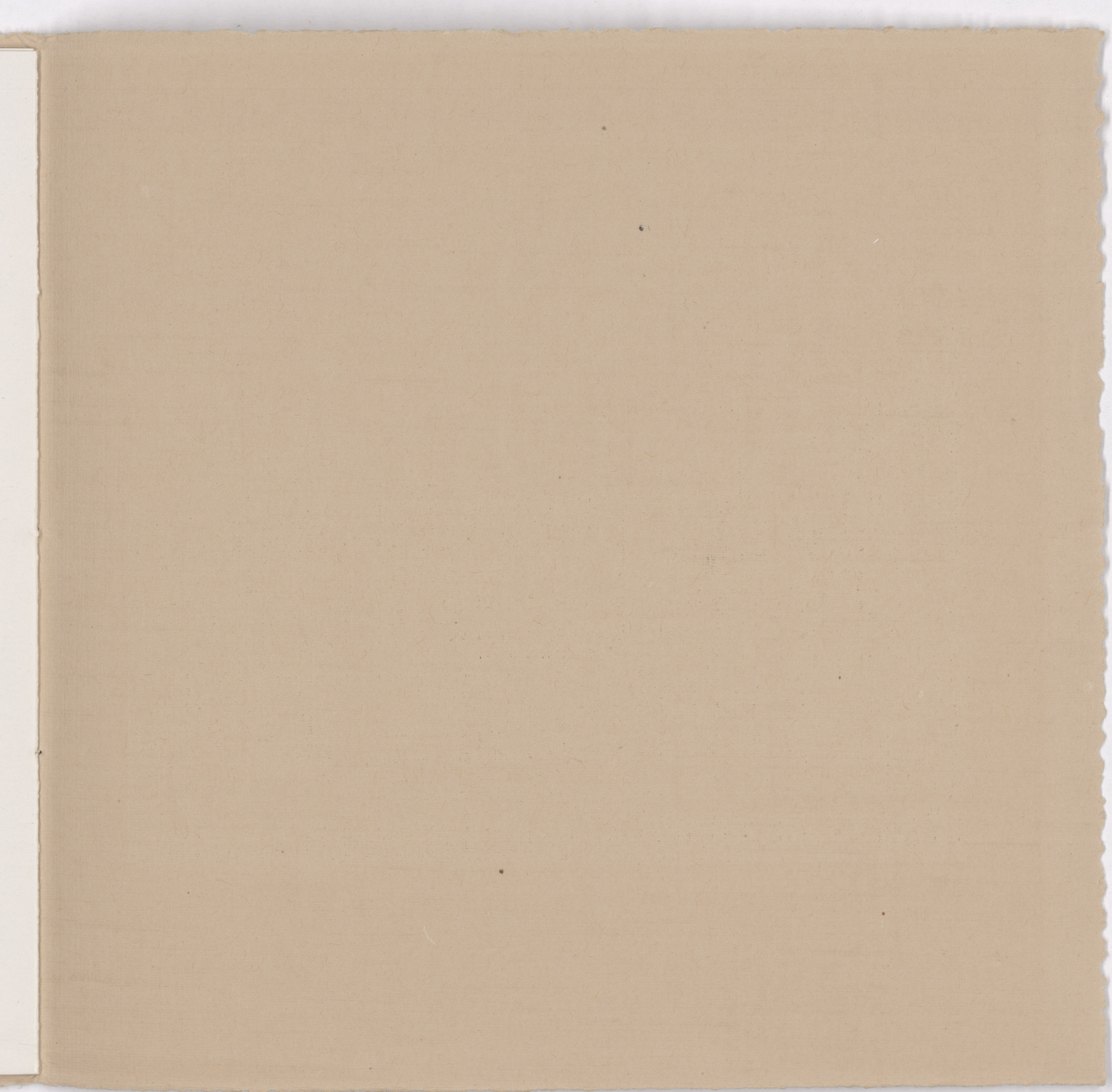

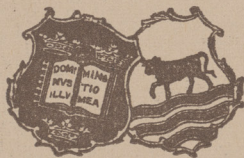

THE CHURCH ARMY PRESS,  
COWLEY, OXFORD.